

# Recent CDF Results

Aaron Dominguez  
LBNL

August 8, 2003

- Status and tools
- QCD
  - Inclusive Jet Cross Section
  - $\gamma$ +Heavy Quark
- Electroweak
  - $W\gamma$  and  $Z\gamma$  Coupling
  - $WW$  Cross Section
- Top
  - Lepton+Jets
  - Dilepton
  - Mass
- Bottom
  - $B_s$  and  $\Lambda_b$
  - New Br, mass and lifetime measurements
- New Physics/Phenomena
  - $B_{s,d} \rightarrow \mu^+ \mu^-$
  - Leptoquarks
  - $Z'$ , Graviton/Extra dimensions

# Luminosity

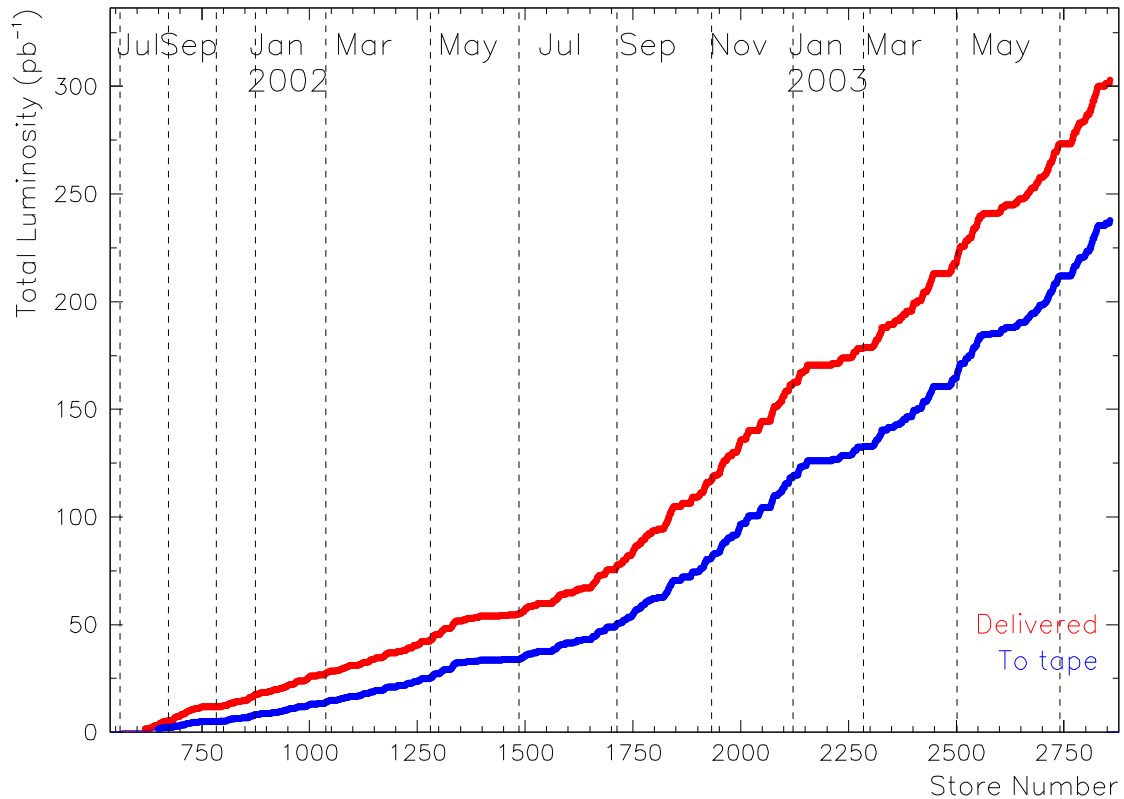

- Now have **more data than Run I**
- Can do **precision measurements and searches**
- Following are some **new, recently updated or unique** CDF results
- Many analyses presented use  $110\text{-}170 \text{ pb}^{-1}$
- B-Physics results use  $72 \text{ pb}^{-1}$

## Status of Silicon Detectors

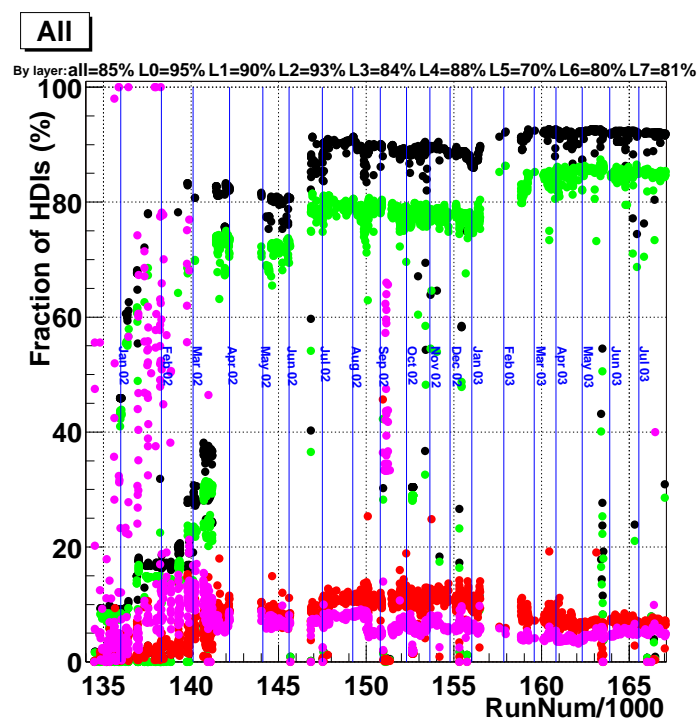
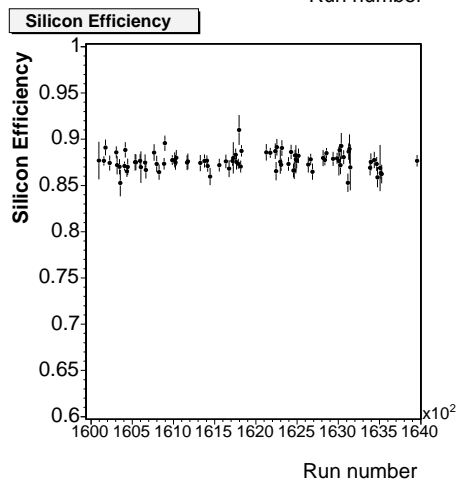
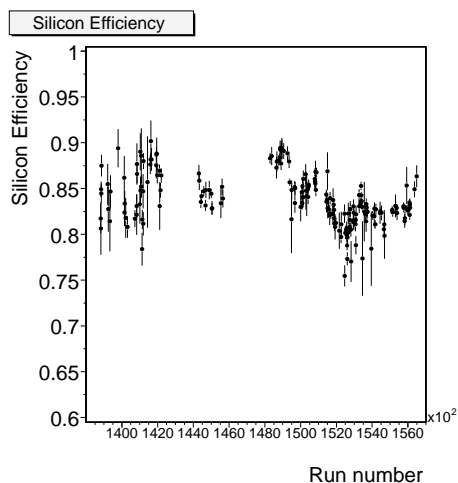

- Detector more stable, Coverage increasing from repairs
- As consequence, Si tracking eff higher, stable since shutdown
- Live SVT wedges now  $\sim 95\%$

## High- $P_t$ B-Tagging

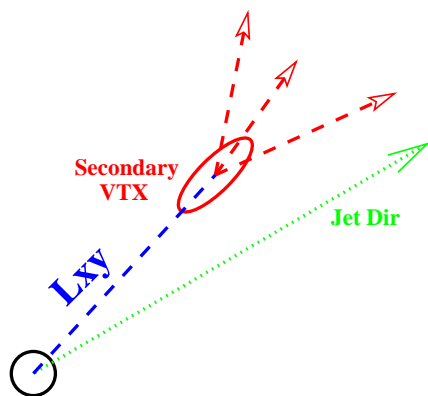

Reference VTX from beamline

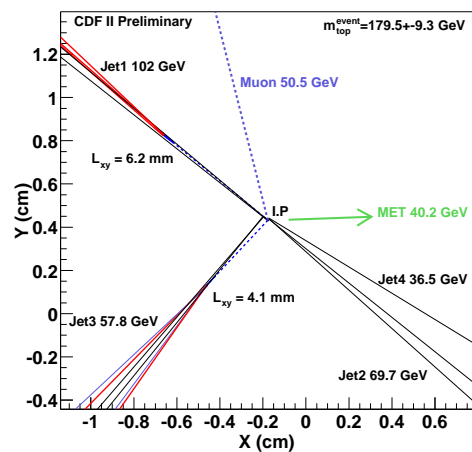

- **Displaced vertexes:** All combinations of at least 2 good tracks
- Jet is tagged as b-jet if  $L_{xy}/\sigma_{xy} > 3$  (typical  $\sigma_{xy} \sim 150 \mu\text{m}$ )
- Performance/alignment/understanding of Si detectors crucial
- Measure eff and fake rate in incl lepton & generic jet data
- Tagger for **high-Pt physics** (QCD, top, Higgs...)

## High- $P_t$ B-Tagging Performance

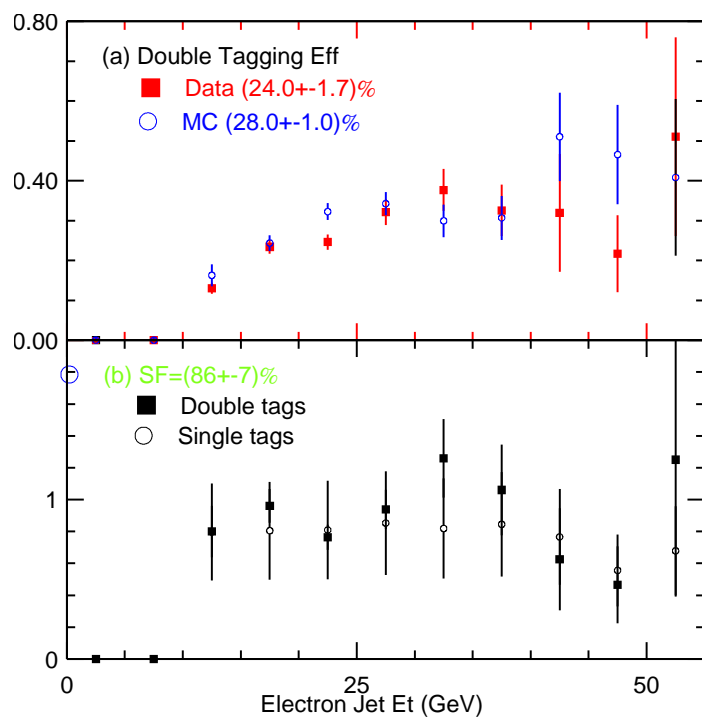

- Relative difference between data/MC  $86\% \pm 7\%$
- Eff to tag a  $t\bar{t}$  event  $55\% \pm 1\% \pm 5\%$
- Prob. for fake jet-tag for top candidates  $\sim 1 - 1.5\%$

## Inclusive Jet Cross Section

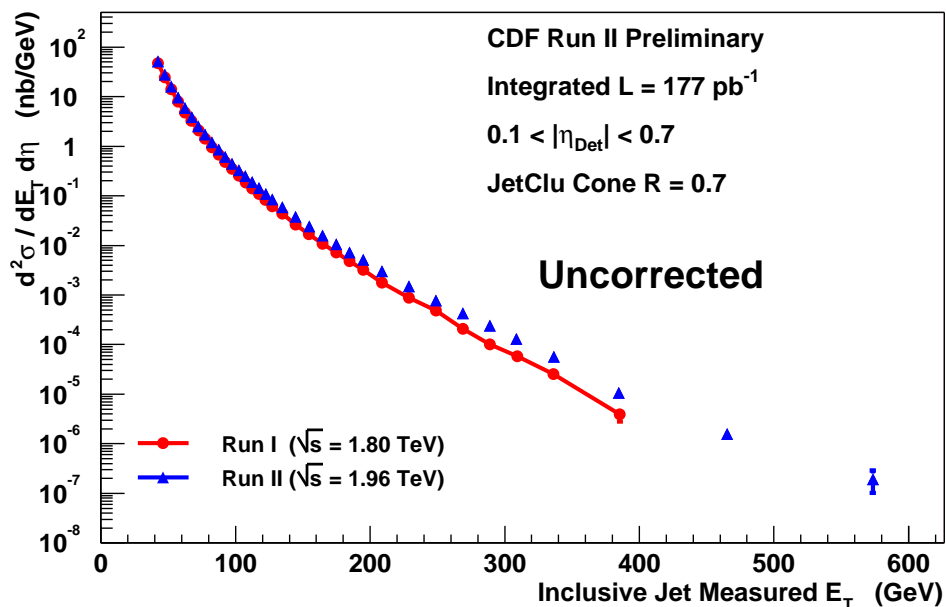

- $\int L$  of 177 pb<sup>-1</sup> collected from Feb 2002 though June 2003.
- Highest  $E_T$  jets ever
- Now extending past Run I reach by almost 150 GeV
- Have reduced largest syst error from 5% to 3% since winter (jet energy)
- Can expect to reach 1% eventually

- Understanding jet cross section is **cornerstone** of doing physics at **hadron collider**

## Inclusive Jet Cross Section vs NLO QCD

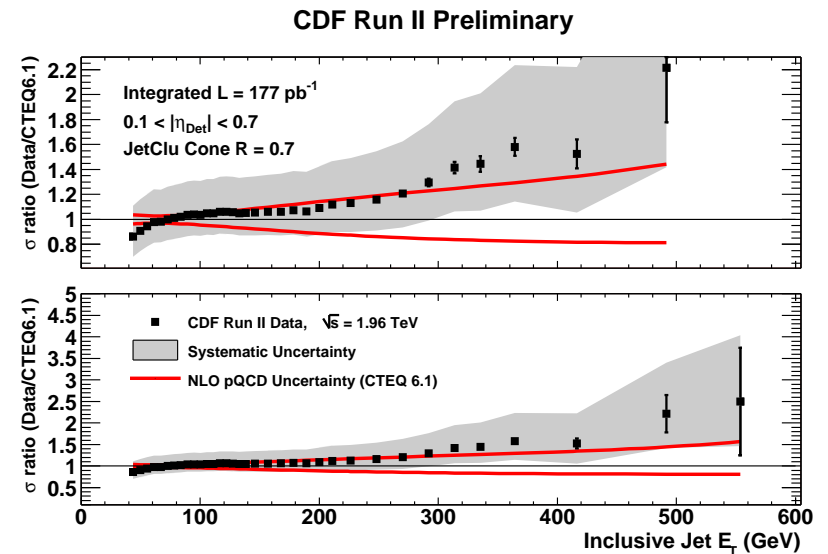
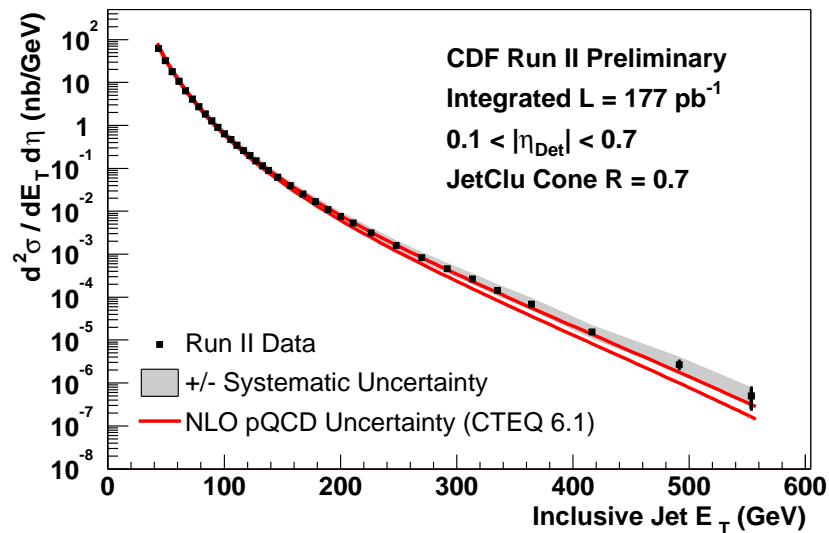

- **Theoretical error** dominated by PDF's (high x gluons)
- Full RunII dataset will help reduce this uncertainty
- But data currently agrees with **NLO prediction** within estimated errors
- Must still understand trends

## Photon+Heavy Flavor

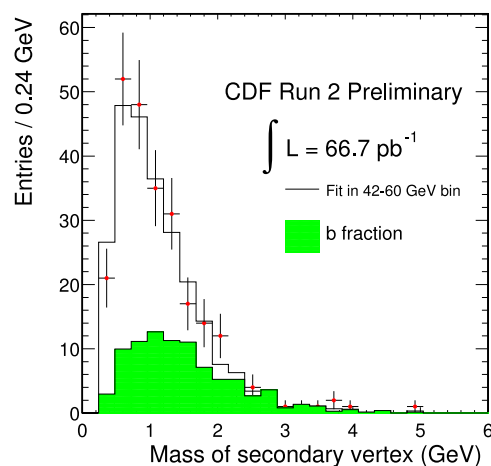
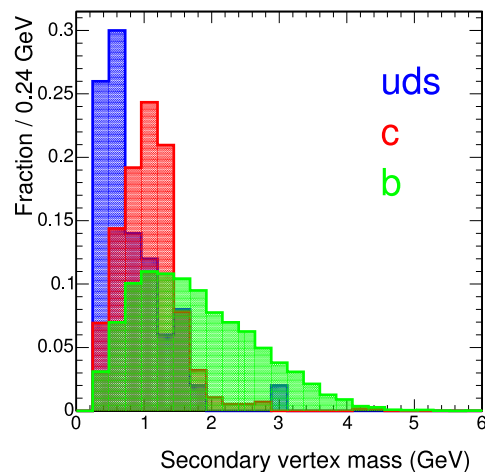

- Measure  $\gamma + b, c$  cross-sections as function of photon  $E_T$
- Test QCD predictions for  $b\bar{b}$  &  $c\bar{c}$  production at different energy scales
- Require central photon
- b-tagged jet
- Fit secondary vtx mass dist for  $b/c$ /light content
- Subtract fakes and extract production cross sections



## Photon+Heavy Flavor Limits

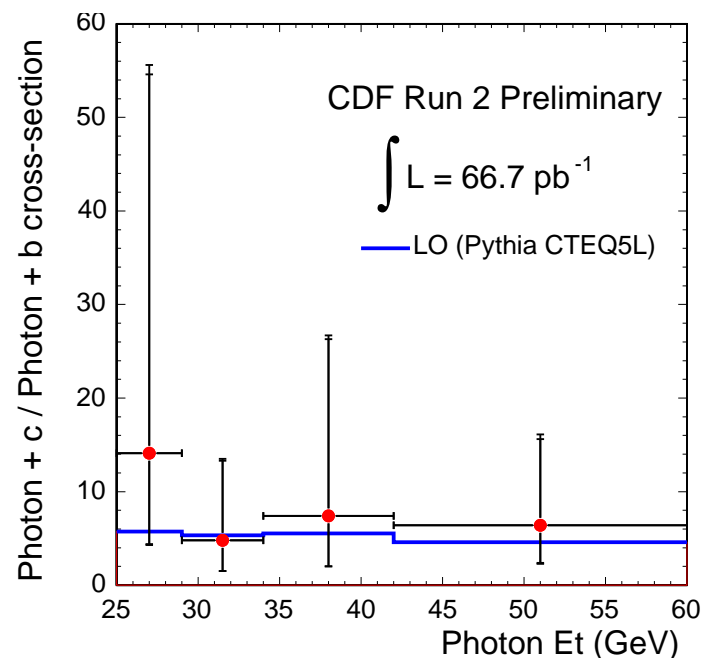
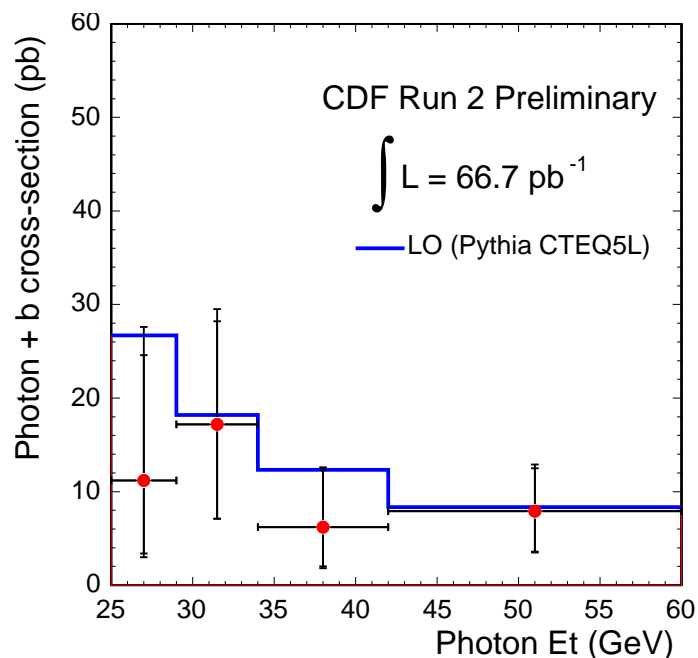

- Extract  $b$  and  $c$  cross sections ( $b$  shown)
- Individual and ratio of  $b/c$  is in agreement with NLO predictions
- **Statistics limited**. Will improve with more luminosity
- **Excess** in  $\gamma + b, c$ , especially at **high  $E_T$** , could signal new physics (light stop,...)

## $W\gamma$ and $Z\gamma$ Couplings

$$p\bar{p} \rightarrow W\gamma \rightarrow \gamma\ell\nu$$

- Tests **triple gauge coupling** which are precisely predicted by SM
- Sensitive to **anomalous couplings**
- Measure cross section and kinematics
- Uses  $128 \text{ pb}^{-1}$
- Require 1 high  $P_T$   $e, \mu$ , missing  $E_T$  and isolated **photon** with  $E_T > 7 \text{ GeV}$

$$p\bar{p} \rightarrow Z\gamma \rightarrow \gamma\ell^+\ell^-$$

- Similar to  $W\gamma$ , but no s-channel
- Now extended acceptance by including plug calorimeter for  $Z\gamma$  plug-central candidates
- Instead of missing  $E_T$ , 2 opp sign high  $P_T$  leptons
- Have reduced systematic error on photon ID

	Events	$S/B$	Meas $\sigma(\text{pb})$	SM $\sigma(\text{pb})$
$W\gamma \rightarrow \gamma\ell\nu$	133	2.4	$17.2 \pm 1.8 \pm 2.2 \pm 1.0$	$18.6 \pm 1.3$
$Z\gamma \rightarrow \gamma\ell^+\ell^-$	47	15	$5.8 \pm 1.0 \pm 0.4 \pm 0.4$	$5.3 \pm 0.4$

## $W\gamma$ and $Z\gamma$ Couplings

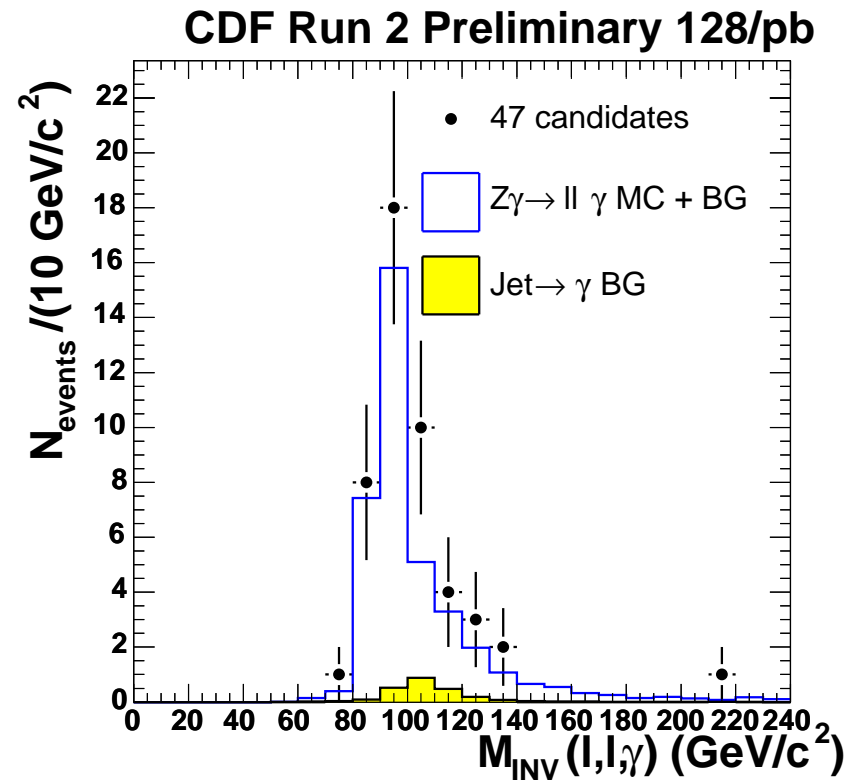
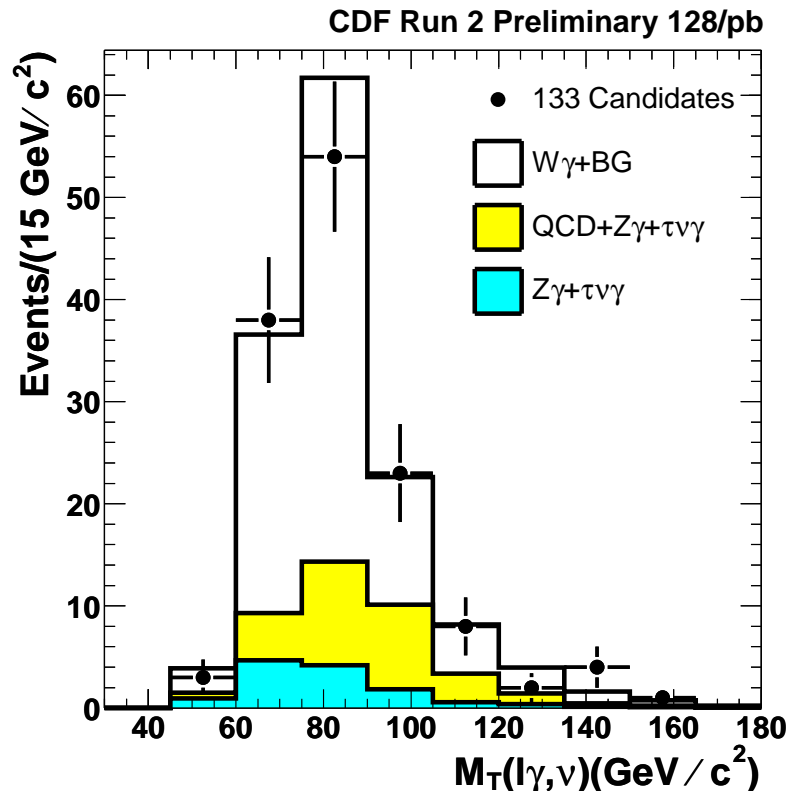

Cross sections and mass spectra currently consistent with SM

Will extract anomalous couplings limits

## WW Cross Section

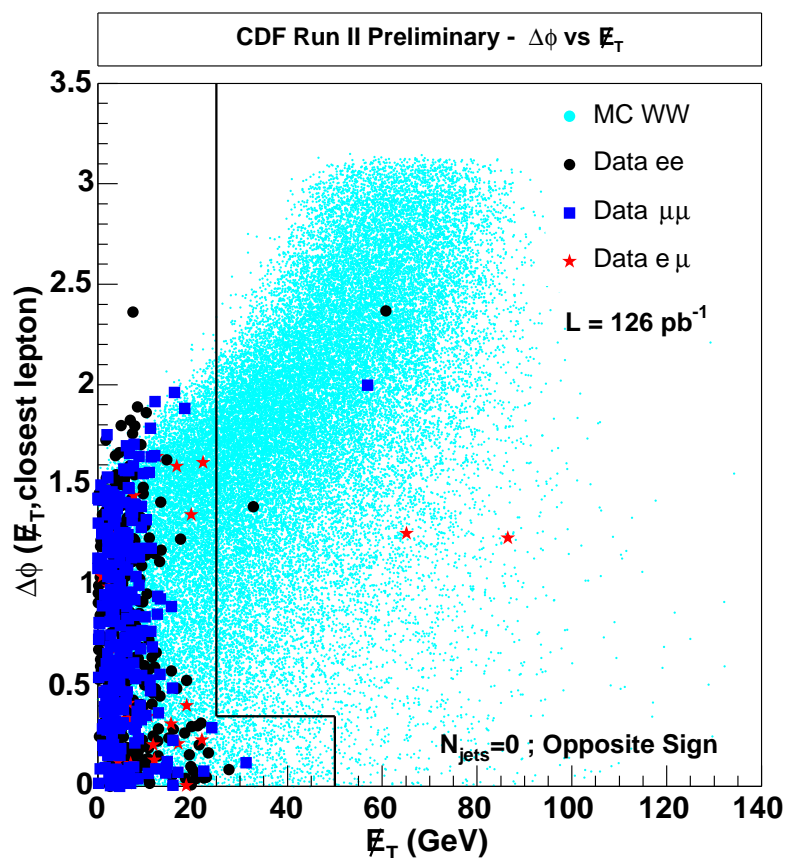

- $p\bar{p} \rightarrow WW \rightarrow \ell\ell'\nu\nu'$  ( $\ell = e, \mu$ )
- Important SM process, kinematically similar  $H \rightarrow WW$  events, bkg for top
- Uses 126 pb<sup>-1</sup>
- Requires
  - 2 high  $P_T$  isolated central, opp charge leptons
  - Large missing  $E_T$
  - Veto  $Z$  and jets

# WW Cross Section

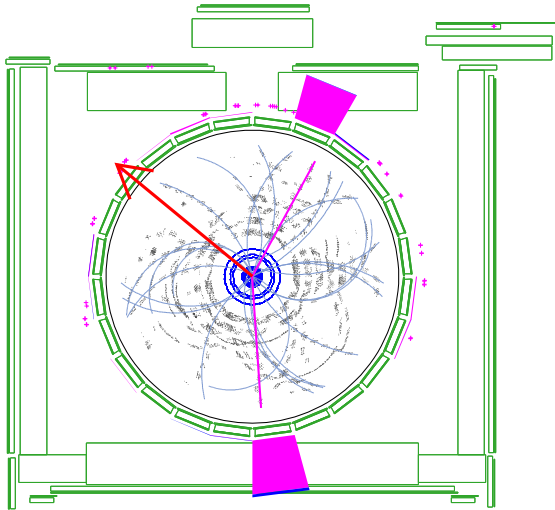

Run 161678 Event 5620107 :  $WW \rightarrow e^+ \nu_e e^- \bar{\nu}_e$  Candidate

$p_T(e^+) = 61.4$  GeV/c;  $p_T(e^-) = 49.6$  GeV/c;  $M_{e^+e^-} = 106.0$  GeV

$\cancel{E}_T = 33.2$  GeV;  $\Phi(\cancel{E}_T) = 2.5$

$\Delta\Phi(\cancel{E}_T, \text{lepton}) = 1.4$ ;  $\Delta\Phi(e^+, e^-) = 2.6$ ;  $\text{Opening-Angle}(e^+, e^-) = 2.0$

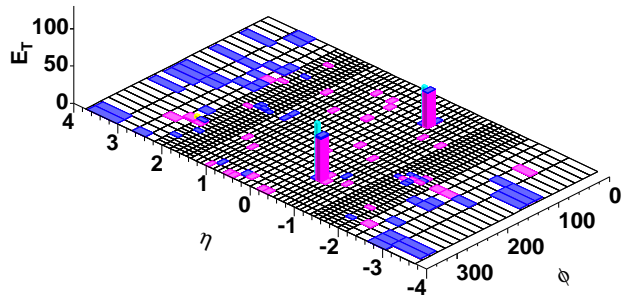

CDF Run II Summer 2003 Preliminary				
Source	$ee$	$\mu\mu$	$e\mu$	$\ell\ell$
Drell-Yan $e^+e^-$	$0.40 \pm 0.19$	$0. \pm 0.$	$0.051 \pm 0.053$	$0.45 \pm 0.19$
Drell-Yan $\mu^+\mu^-$	$0. \pm 0.$	$0.49 \pm 0.22$	$0.35 \pm 0.17$	$0.84 \pm 0.28$
Drell-Yan $\tau^+\tau^-$	$0.024 \pm 0.010$	$0.022 \pm 0.009$	$0.066 \pm 0.025$	$0.11 \pm 0.03$
$WZ$	$0.030 \pm 0.004$	$0.057 \pm 0.007$	$0.11 \pm 0.01$	$0.19 \pm 0.02$
Fake	$0.16 \pm 0.04$	$0.16 \pm 0.09$	$0.40 \pm 0.11$	$0.72 \pm 0.15$
$t\bar{t}$	$0.0039 \pm 0.0030$	$0.0054 \pm 0.0035$	$0.020 \pm 0.009$	$0.029 \pm 0.010$
Total Bkg	$0.61 \pm 0.19$	$0.74 \pm 0.24$	$1.00 \pm 0.21$	$2.34 \pm 0.38$
$WW \rightarrow \ell^+\ell^-$	$1.61 \pm 0.37$	$1.36 \pm 0.31$	$3.92 \pm 0.89$	$6.89 \pm 1.53$
<b>Run 2 Data</b>	2	1	2	5

$$\sigma(WW) = 5.1_{-3.6}^{+5.4}(\text{stat}) \pm 1.3(\text{syst}) \pm 0.3(\text{lumi}) \text{ pb}$$

$$\sigma(WW)_{\text{NLO}} = 13.3 \pm 0.3 \text{ pb (Campbell, Ellis)}$$

## Top Physics Studies

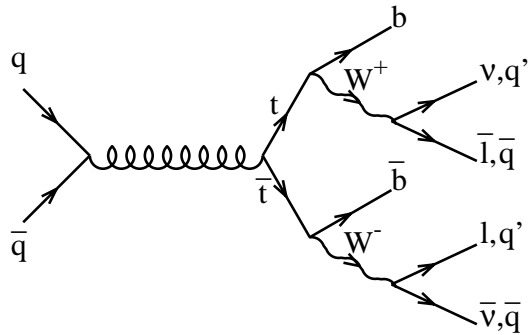

- Final states (2 B-jets & W's)
  - Dilepton ( $2 W \rightarrow l\nu$ )
  - Lepton+jets ( $W \rightarrow l\nu, W \rightarrow qq'$ )
  - All hadronic ( $2 W \rightarrow qq'$ )
- Lepton+jets
  - Higher stats than dilepton chan
  - Less bkg than all hadronic chan
- Dilepton
  - 2 well id'd leptons: high  $S/B$
  - 1 well id'd lepton + iso track: higher stats

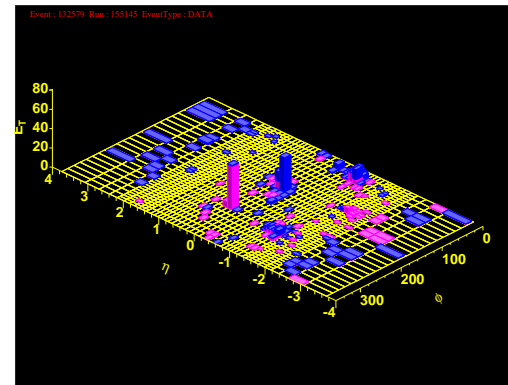
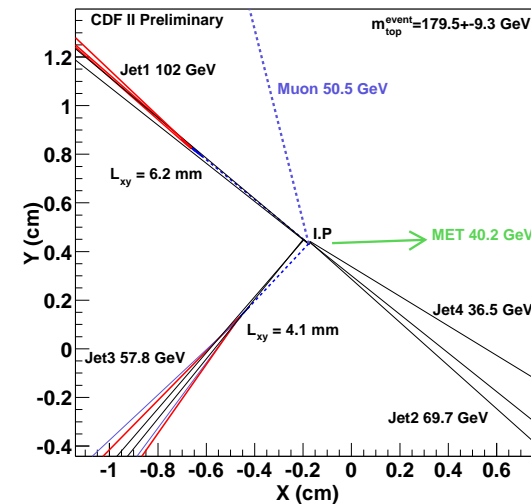

## Top: Lepton+Jets Cross Section

- Signature:
  - One high- $P_t$  isolated lepton
  - Veto Z's, cosmics and conversions
  - Large missing  $E_t$
  - At least 4 or more high  $E_t$  jets

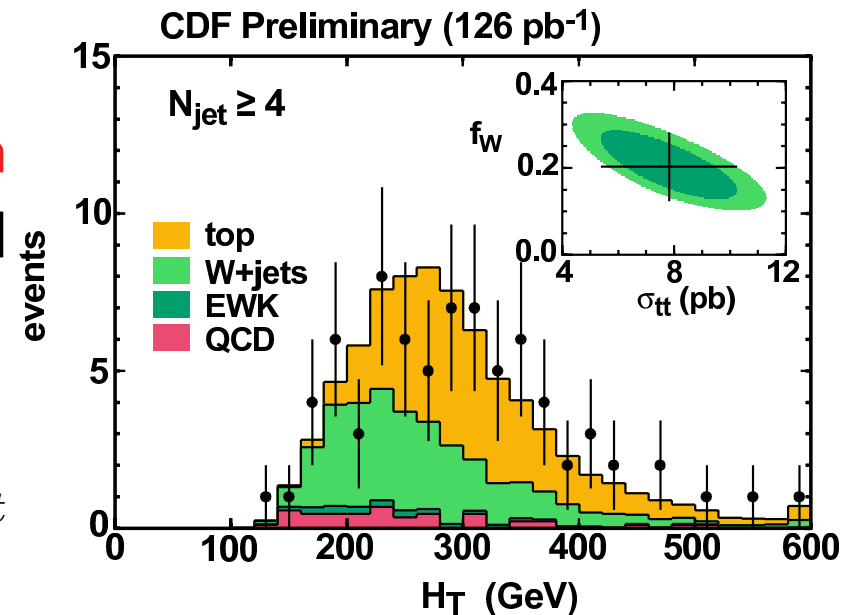

- Extract cross-section with fit to shape of  $H_T$

- Find 75 candidate events in 107.9 pb<sup>-1</sup>
- Fit 51%  $\pm$  16% to be top events
- $\sigma_{t\bar{t}}(\text{NLO}) = 6.7^{+0.71}_{-0.88}$  pb (Mangano et al)

$$\sigma(t\bar{t}) = 7.1 \pm 2.4(\text{stat}) \pm 3.0(\text{sys}) \text{ pb}$$

## Top: Mass in Lepton+Jets Events

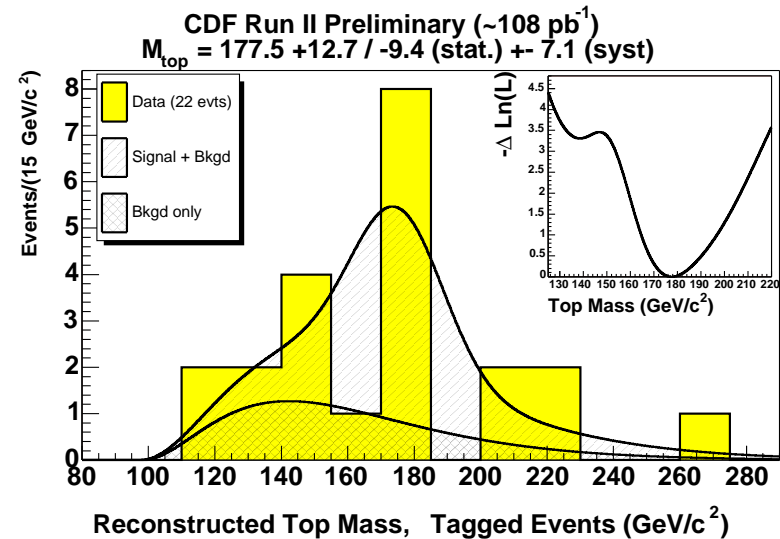
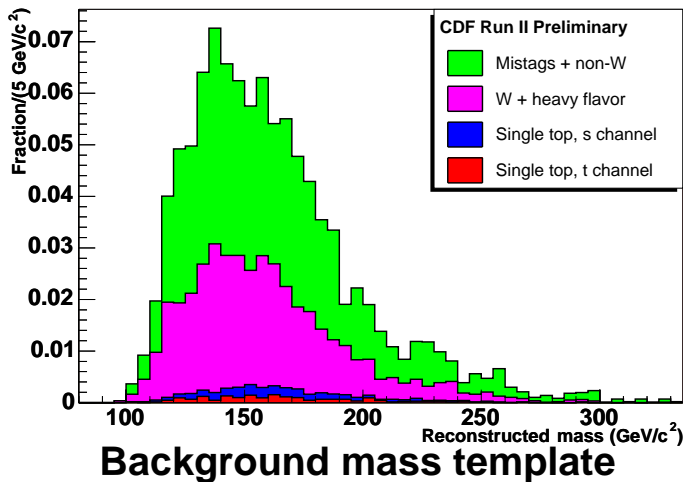

- Same sample as for cross section
- Require  $\geq 4$  jets
- Measure  $m_t$  with  $\geq 1$  b-tag
- Find 22 candidate events with b-tag

- Expect  $5.9 \pm 2.1$  bkg events
- Make 2C mass fit of each event
- Extract  $m_t$  using likelihood fit to simulated mass templates for signal & bkg

$$m_t = 177.5_{-9.4}^{+12.7} \text{ (stat)} \pm 7.1 \text{ (syst)} \text{ GeV}$$



## Top: Lepton+Track Cross Section

- Dilepton is clean, but low stats channel  $\Rightarrow$  open acceptance with looser requirements
- Require 1 tight lepton and 1 isolated track
  - 1  $e$  or  $\mu$  in central detectors
  - 1 isolated track with  $P_T > 15$  GeV,  $|\eta| < 1$
- Has significant (25%) sensitivity to  $\tau$ -channel
- Missing  $E_T > 25$  GeV (corrected for lepton and track)
- $\geq 2$  jets with  $E_T > 15$  GeV

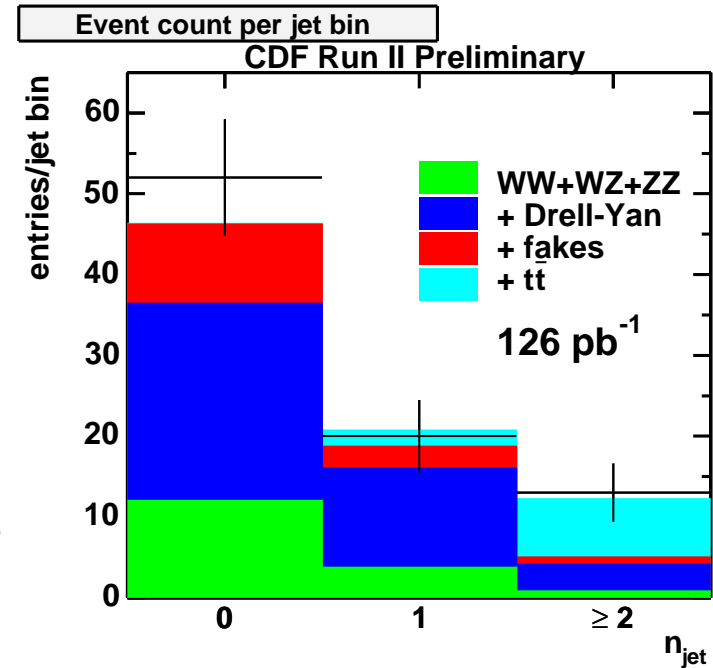

$$\sigma(t\bar{t}) = 7.3 \pm 3.4(\text{stat}) \pm 1.7(\text{syst}) \text{ pb}$$

## Top: Mass in Dilepton Events

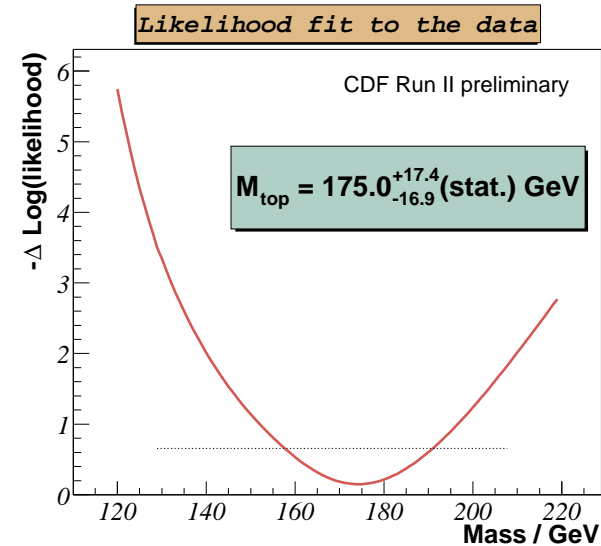
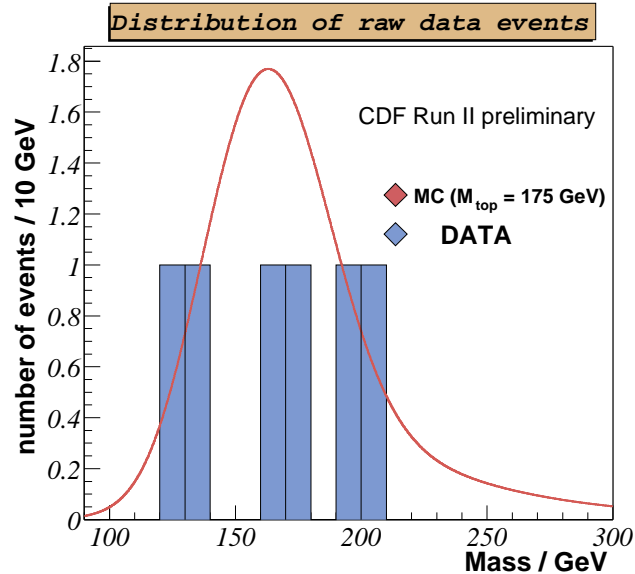

- Traditional tight-tight dilepton analysis
- Veto  $m_Z$  and large missing  $E_T$ , cosmics
- 2 well identified & isolated leptons,  $E_T > 20 \text{ GeV}$ , opp charge
- Large  $H_T > 200 \text{ GeV}$
- Event-by-event kinematic fit

$$m_t = 175.0^{+17.4}_{-16.9} \pm 7.9 \text{ GeV}$$

## Bottom: $B_s$ and $\Lambda_b$

$B_s^0$ DECAYMODES	Fraction( $\Gamma_i/\Gamma$ )	Confidence level	(MeV/c)
$D_s^-$ anything	(94 ± 30) %	–	–
$D_s^- \ell^+ \nu_\ell$ anything	[iii] (7.9 ± 2.4) %	–	–
$D_s^- \pi^+$	< 13 %	2321	–
$D_s^*(*)+ D_s^*(*)-$	(23 $^{+21}_{-13}$ ) %	–	–
$J/\psi(1S)\phi$	(9.3 ± 3.3) × 10 <sup>-4</sup>	1590	–
$J/\psi(1S)\pi^0$	< 1.2 × 10 <sup>-3</sup>	90%	1788
$J/\psi(1S)\eta$	< 3.8 × 10 <sup>-3</sup>	90%	1735
$\psi(2S)\phi$	seen	1122	–
$\pi^+\pi^-$	< 1.7 × 10 <sup>-4</sup>	90%	2681
$\pi^0\pi^0$	< 2.1 × 10 <sup>-4</sup>	90%	2681
$\eta\pi^0$	< 1.0 × 10 <sup>-3</sup>	90%	2655
$\eta\eta$	< 1.5 × 10 <sup>-3</sup>	90%	2628
$\rho^0\rho^0$	< 3.20 × 10 <sup>-4</sup>	90%	–
$\phi\rho^0$	< 6.17 × 10 <sup>-4</sup>	90%	–
$\phi\phi$	< 1.183 × 10 <sup>-3</sup>	90%	–
$\pi^+K^-$	< 2.1 × 10 <sup>-4</sup>	90%	2660
$K^+K^-$	< 5.9 × 10 <sup>-5</sup>	90%	2639
$\bar{K}^*(892)^0\rho^0$	< 7.67 × 10 <sup>-4</sup>	90%	–
$\bar{K}^*(892)^0K^*(892)^0$	< 1.681 × 10 <sup>-3</sup>	90%	–
$\phi K^*(892)^0$	< 1.013 × 10 <sup>-3</sup>	90%	–
$p\bar{p}$	< 5.9 × 10 <sup>-5</sup>	90%	2515
$\gamma\gamma$	< 1.48 × 10 <sup>-4</sup>	90%	2685
$\phi\gamma$	< 7 × 10 <sup>-4</sup>	90%	2588
<b>Lepton Family number (LF) violating modes or <math>\Delta B = 1</math> weak neutral current (B1) modes</b>			
$\mu^+\mu^-$	B1 < 2.0 × 10 <sup>-6</sup>	90%	2682
$e^+e^-$	B1 < 5.4 × 10 <sup>-5</sup>	90%	2864
$e^\pm\mu^\mp$	LF [ff] < 6.1 × 10 <sup>-6</sup>	90%	2864
$\phi\nu\bar{\nu}$	B1 < 5.4 × 10 <sup>-3</sup>	90%	–

$\Lambda_b^0$ DECAYMODES	Fraction( $\Gamma_i/\Gamma$ )	Confidence level	(MeV/c)
$J/\psi(1S)\Lambda$	(4.7 ± 2.8) × 10 <sup>-4</sup>	1744	–
$\Lambda_c^+\pi^-$	seen	2345	–
$\Lambda_c^+a_1(1260)^-$	seen	2156	–
$\Lambda_c^+\ell^-\bar{\nu}_\ell$ anything	[s] (7.7 ± 1.8) %	–	–
$p\pi^-$	< 5.0 × 10 <sup>-5</sup>	90%	2732
$pK^-$	< 5.0 × 10 <sup>-5</sup>	90%	2711

- Unique program of  $B_s$  and  $\Lambda_b$  physics making an impact: Yellow are recent results, green are new results compared to PDG02/03
- $B_s$  is currently poorly measured particle
  - Measured Br's
  - Rare decays
  - Also have new results for mass & lifetime
- Largest sample of identified  $\Lambda_b^0$ 
  - Measured Br's
  - Also have new results for mass & lifetime

## Bottom: $\Lambda_b^0 \rightarrow \Lambda_c^+ \pi^-$ Observation & Branching Fraction

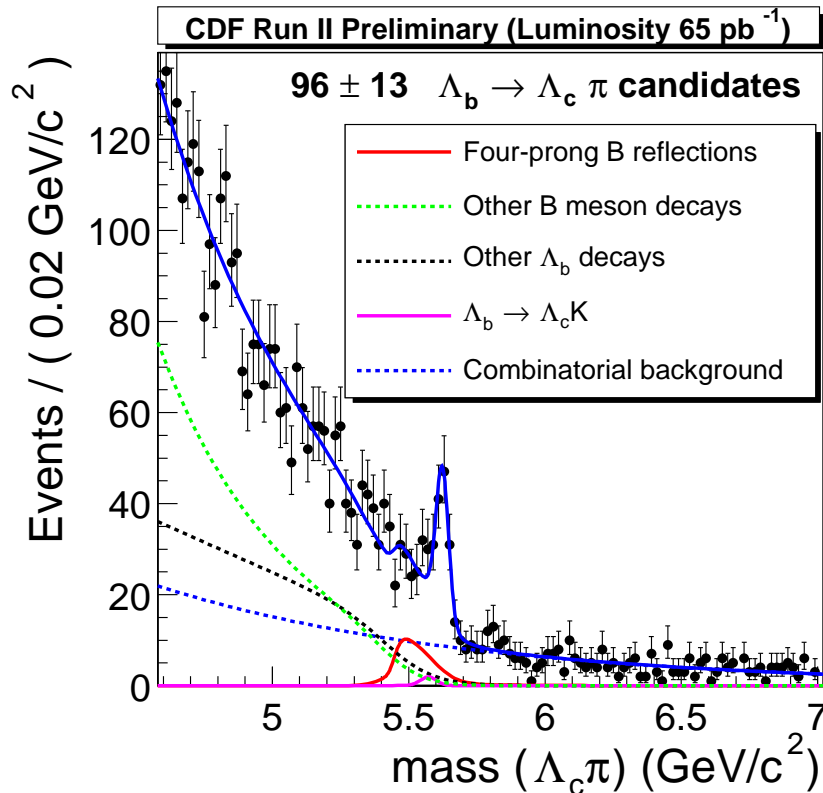

- Uses **hadronic displaced track trigger (SVT)**
- Use decay mode  $\Lambda_c^+ \rightarrow p^+ K^- \pi^+$
- $P_T(p) > 2 \text{ GeV}$
- $P_T(\pi \text{ from } \Lambda_b) > 2 \text{ GeV}$
- $P_T(\Lambda_c^\pm) > 7.5 \text{ GeV}$
- $c\tau(\Lambda_c \text{ from } \Lambda_b) > -65 \mu\text{m}$
- Impact par of  $\Lambda_b < 85 \mu\text{m}$
- $2.269 \text{ GeV} < m_{\Lambda_c} < 2.302 \text{ GeV}$
- Measure branching relative to well known  $\bar{B}^0 \rightarrow D^+ \pi^-$
- Use  $f_{\text{baryon}}/f_d$  from PDG as input

$$\frac{\text{Br}(\Lambda_b \rightarrow \Lambda_c^+ \pi^-)}{\text{Br}(\bar{B}^0 \rightarrow D^+ \pi^-)} = 2.2 \pm 0.4(\text{stat}) \pm 0.3(\text{sys}) \pm 0.7(\text{Br} + \text{Fr})$$

## Bottom: $B_s^0 \rightarrow K^\mp K^\pm$ Observation

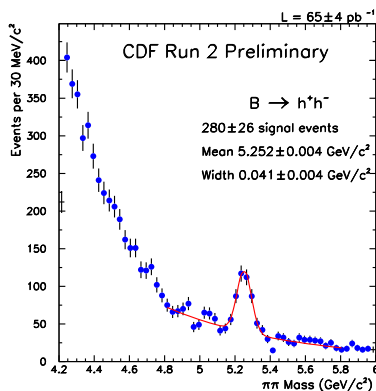
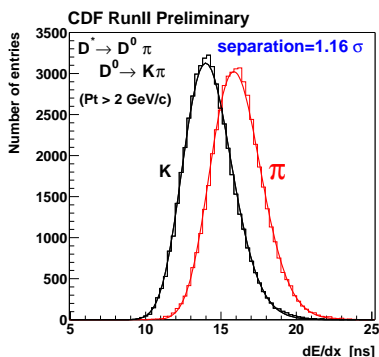

- Uses **SVT**
- Melange of 4 hadronic modes:  $B_d \rightarrow \pi\pi$ ,  $B_d \rightarrow K\pi$ ,  $B_s \rightarrow K\pi$ ,  $B_s \rightarrow KK$
- Statistically disentangle using invariant mass ( $M_{\pi\pi}$ ) and relative momentum ( $((1 - p_1/p_2)q_1)$ )
- Require 2 tracks with impact par  $> 150 \mu\text{m}$
- $L_{xy}(B) > 300 \mu\text{m}$ , but impact par  $< 80 \mu\text{m}$
- Use PID for  $K$  and  $\pi$
- Perform Log-Like fit to 2D  $M_{\pi\pi}$ ,  $\alpha$  dist including PID
- Can extract,  $A_{CP}$ , relative  $Br$  and rel. Br of  $B_s \rightarrow KK$

$$B_s \rightarrow KK = 90 \pm 17(\text{stat}) \pm 17(\text{sys}) \text{ events}$$

$$\frac{f_s \cdot \text{Br}(B_s \rightarrow K^\pm K^\mp)}{f_d \cdot \text{Br}(B_d \rightarrow K^\pm \pi^\mp)} = 0.75 \pm 0.20 \pm 0.22$$

## Exotics: $B_{s,d}^0 \rightarrow \mu^+ \mu^-$ Search

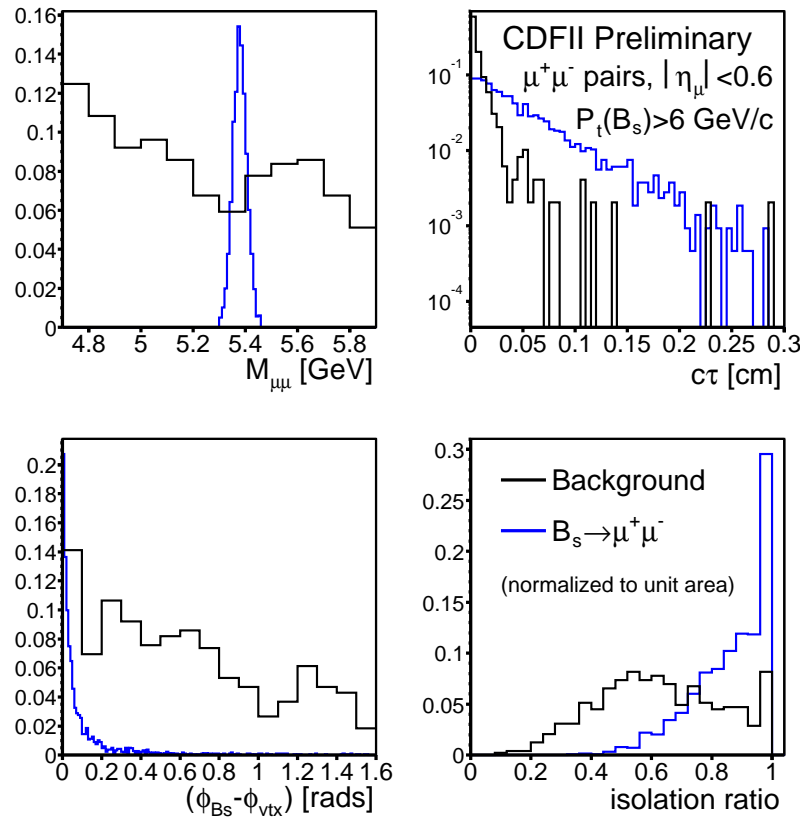

- $B_s$  can also be used to search for new physics with **FCNC**  $B_s \rightarrow \mu^+ \mu^-$
- SM  $Br \sim 3.8 \times 10^{-9}$ , but SUSY predict enhancements by 1-3 orders of mag
- Recent interest due to predicted deviations of  $(g - 2)_\mu$  from SUSY lie in par-space with large  $B_s \rightarrow \mu^+ \mu^-$  ([hep-ph/0207026](#) and [hep-ph/0203069](#))
- Signal is pair of opp. sign muons with inv. mass consistent with  $B_s$
- Use rare-B dimuon trigger and **discriminating variables**
- Mass windows of  $\pm 3\sigma$  for  $B_s$  and  $B_d$
- Interpolate bkg from sidebands
- Use measured  $\sigma(B_s)$  for denominator

## Exotics: $B_{s,d}^0 \rightarrow \mu^+ \mu^-$ Limit

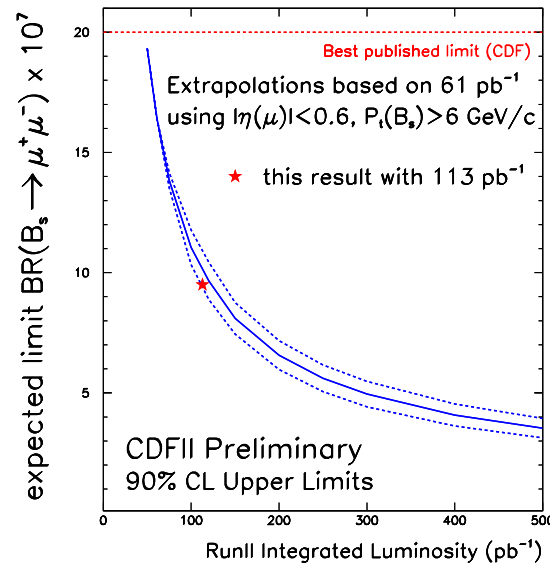
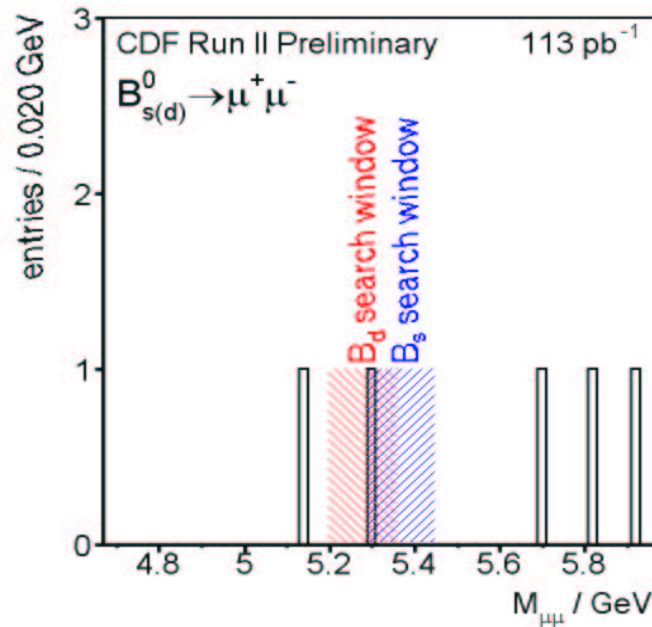

- Optimized cuts on discriminating vars:  $c\tau > 200 \mu\text{m}$ ,  $\Delta\Phi < 100 \text{ mrad}$ ,  $\text{Iso} > 0.65$
- Total  $B_s$  signal eff of 1.89% with bkg of  $0.0048 \pm 0.0018 \text{ pb}$ . Similar for  $B_d$ .
- One shared candidate
- World's best limit:  $\text{Br}(B_s^0 \rightarrow \mu^+ \mu^-) < 9.5 \times 10^{-7} @ 95\% \text{ CL}$
- $B_d$  will be competitive with more lumi:  $\text{Br}(B_d^0 \rightarrow \mu^+ \mu^-) < 2.5 \times 10^{-7} @ 95\% \text{ CL}$

## Exotics: 1<sup>st</sup> Generation Leptoquarks

- **Leptoquarks (LQ)**: Predicted by several extensions to SM (GUTS, SUSY w/RP-violation, Technicolor...)
- Carry lepton & baryon quantum numbers
- LQ pair produced by  $gg$ -fusion &  $q\bar{q}$ -annihilation
- To avoid FCNC's, assume LQ couple to lepton/quark of same generation
- Search as function of  $\beta \equiv$  **branching into chg leptons**:

Channel	SM Events Expected	Observed
$\nu_e \bar{\nu}_e u \bar{u}$	$42.5 \pm 7.6 \pm 7.5$	42
$e^+ e^- u \bar{u}$	$3.39 \pm 3.15$	0
$e \nu_e u \bar{u}$	$1.73 \pm 1.47$	2

- $\nu_e \bar{\nu}_e u \bar{u}$  channel
  - Trigger on missing  $E_T > 45$  GeV
  - Reduce QCD multijets with large opening angle cuts and missing  $E_T > 55$  GeV
  - Reject  $W/Z$ +jets with lepton veto,  $N_{\text{trk}}^{\text{jet}} \geq 4$
  - $W \rightarrow \tau \nu + 2$  jets and  $Z \rightarrow \nu \bar{\nu} + 2$  jets largest bkg
- $e^+ e^- u \bar{u}$  channel
  - High  $P_T$  electron trigger
  - Require 2 well id'd central electrons with  $E_T > 25$  GeV,  $P_T > 10$  GeV
  - At least 1 electron well isolated
  - Largest bkg from  $\gamma/Z \rightarrow e^+ e^- +$  jets
  - Veto  $m_Z$  region
- $e \nu_e u \bar{u}$  channel
  - High  $P_T$  electron and missing  $E_T$
  - Combo of previous two analyses



## Exotics: 1<sup>st</sup> Generation Leptoquarks Limits

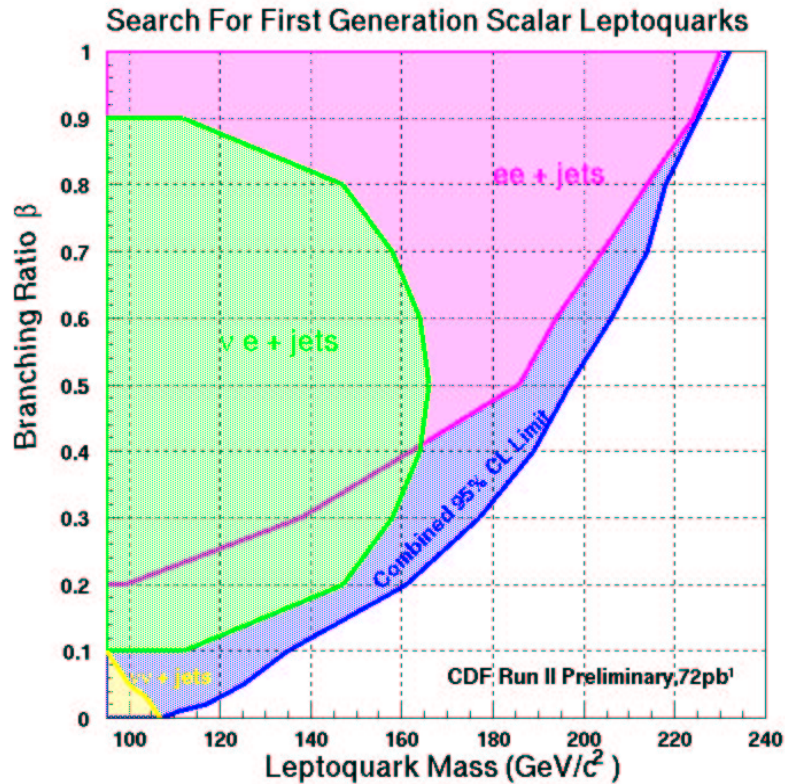

- Combine 3 channels to set mass limits for various  $\beta$
- Accounts for small cross-eff between  $e^+e^-u\bar{u}$  events appearing in  $e\nu_e u\bar{u}$  channel
- $m_{LQ} > 107 \text{ GeV}$  at 95%  $CL$  independent of  $\beta$

## Exotics: $Z'$ and RS Gravitons

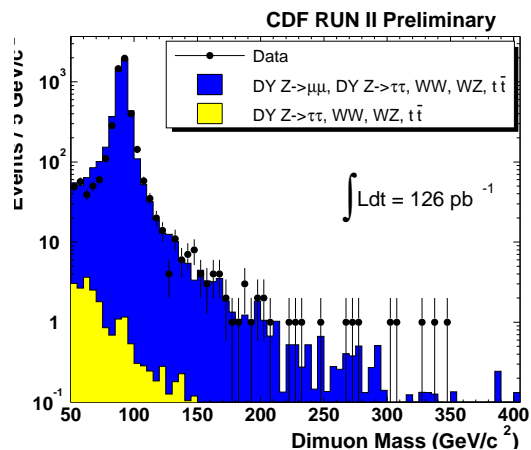
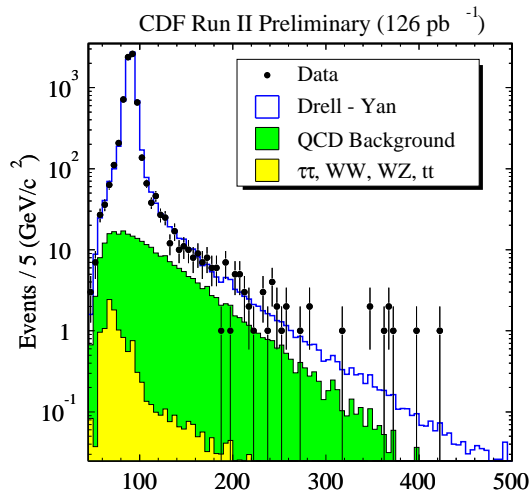

- Search for high mass opp. sign dilepton pairs ( $e^\pm$  or  $\mu^\pm$ )
  - Assume a narrow resonance such as
    - \*  $q\bar{q} \rightarrow Z' \rightarrow \ell^+ \ell^-$  (Extra gauge bosons)
    - \*  $q\bar{q}, gg \rightarrow G \rightarrow \ell^+ \ell^-$  (RS Gravitons)
- Backgrounds from
  - Drell-Yan, QCD, diboson,  $t\bar{t}$ ,  $b\bar{b}$
  - Cosmics large, but easy to id
- $e^+e^-$ 
  - 1 good central e with  $E_T > 25$  GeV
  - 2<sup>nd</sup> good central or plug e  $E_T > 25$  GeV
  - $(\text{missing } E_T) / \sqrt{\sum E_T} < 2.5$
  - Mass window of  $3\sigma$  for each mass pt
- $\mu^+\mu^-$ 
  - 2 good muons
  - Cosmics rejected by COT timing & IP cuts
  - Fixed mass cut of  $M_{\mu\mu} > 250$  GeV

## Exotics: $Z'$ and RS Graviton Mass Limits

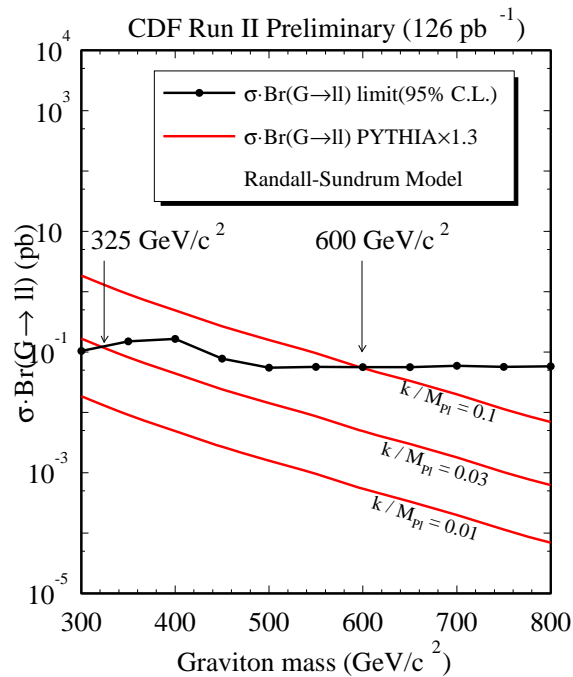
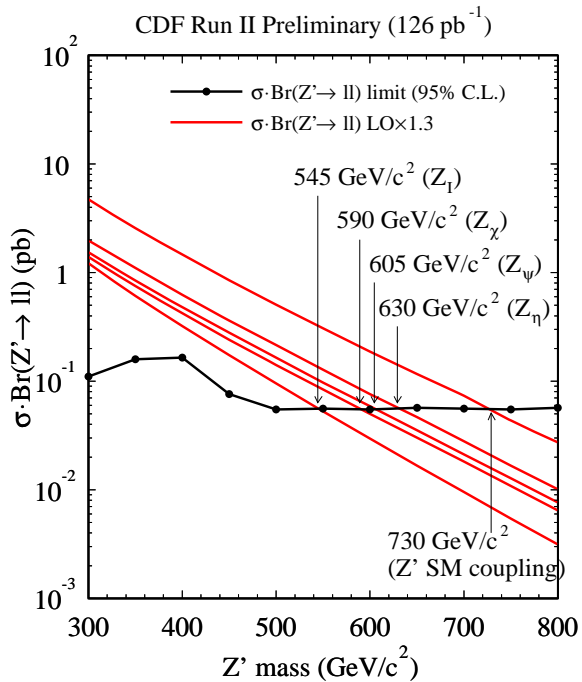

	Mass ( GeV)	SM Expected	Observed
$e^+e^-$	$250 \pm 20$	13.9	15
$\mu^+\mu^-$	$> 250$	5.35	8

## Other Recent CDF Analyses

- Only showed a fraction of all CDF results, much less all the new results
- Many analyses moving towards publication:
  - $A_{fb}$
  - $D^0 \rightarrow \mu^+ \mu^-$ ,  $\text{Br}(D^0)$ ,  $(m_{D_s^+} - m_{D^+})$  and CP Asymm
  - Charm cross section (submitted to PRL), luminosity
- *Many* B-Physics results conference-ready
  - Masses and lifetimes of  $\Lambda_b$ ,  $B_s$ ,  $B^+$ ,  $B^0$
  - Also charm results extremely competitive
- New top measurements: single top search, cross section with b-tag
- Many SUSY/Exotics searches
  - CHAMPS
  - Higgs
  - Traditional SUSY
- Look forward to many new results and publications with luminosity to be delivered until summer shutdown.

## Conclusions

- Have **highest  $E_T$  jets** observed by CDF
- New **top** and **EW** measurements
- Have **first observations of:**
  - $\Lambda_b \rightarrow \Lambda_c^+ \pi^-$
  - $B_s^0 \rightarrow K^\mp K^\pm$
  - $B_s^0 \rightarrow D_s^\mp \pi^\pm$
- World's **best limits** on new phenomena:
  - $B_s \rightarrow \mu^+ \mu^-$
  - Direct search mass limits on  $Z'$

## Thank You

On behalf of CDF and myself,

I would like to thank the beams division for their hard work and successful operation of the accelerator, making world-class physics possible at the Tevatron.

**Backup Slides and Additional Material follow**

## Additional Material: Energy Flow Inside Jets

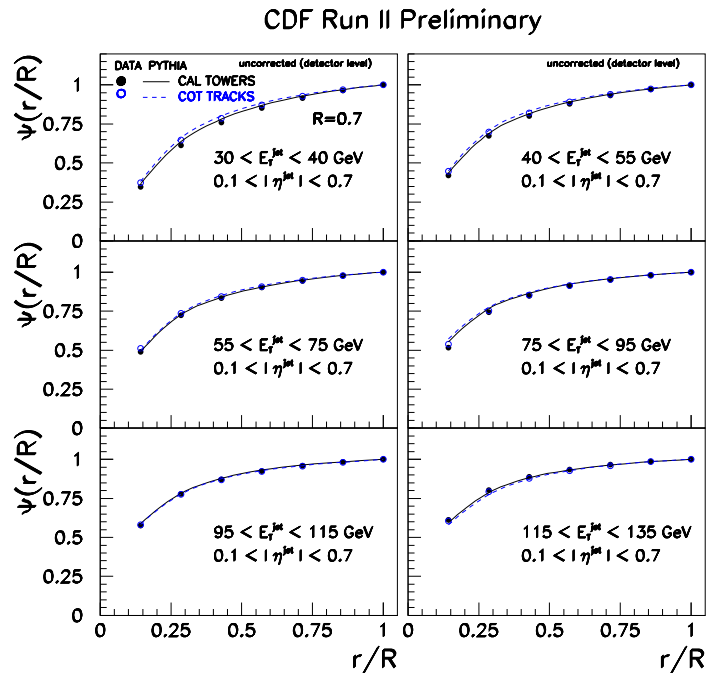
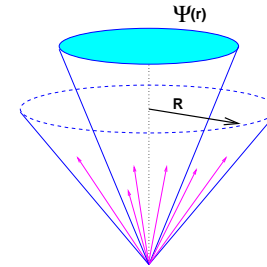

$$\psi(r/R) = \frac{1}{N_{\text{jet}}} \sum_{\text{jet}} \frac{E_T(0,r)}{E_T^{\text{jet}}(0,R)}$$

- Jet Shape: fractional energy flow inside jets
- In central region can do with both tracks and cal
- Shapes nearly identical, data MC agree well
- Many High  $E_T$  analyses depend on well understood jet properties



## Additional Material: $B_s^0 \rightarrow D_s^\mp \pi^\pm$ Observation & Branching Fraction

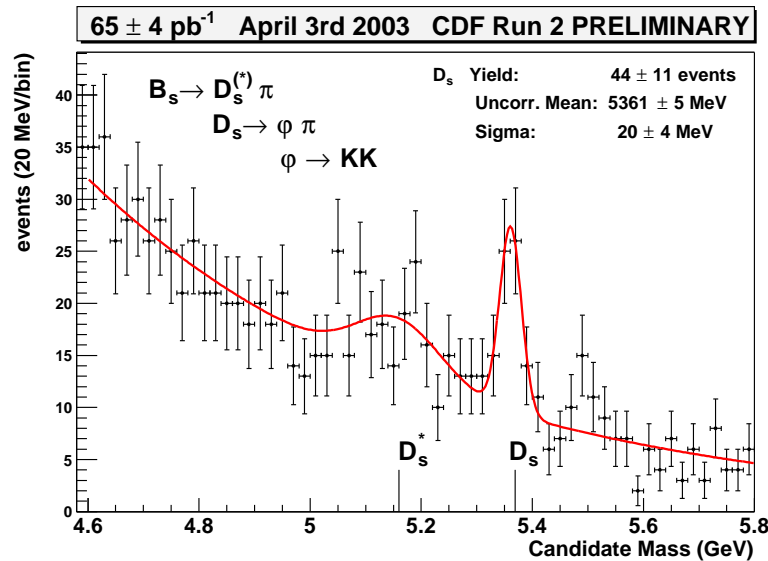

- Uses **SVT**
- Use decay mode  $D_s \rightarrow \phi \pi$  with  $\phi \rightarrow K^+ K^-$
- $1.013 \text{ GeV} < m_{KK} < 1.028 \text{ GeV}$
- $m_{D_s} = 1968.5 \text{ MeV}$  from PDG
- $P_T(D_s) > 4 \text{ GeV}$
- $P_T(B_s) > 4 \text{ GeV}$
- $L_{xy}(D_s) > 400 \mu\text{m}$
- $L_{xy}(B_s) > 100 \mu\text{m}$
- Impact par of  $B_s < 100 \mu\text{m}$
- Measure branching relative to well known  $B_d^0 \rightarrow D^\mp \pi^\pm$
- Use  $f_s/f_d$  from PDG as input

extract  $\frac{\text{Br}(B_s \rightarrow D_s \pi)}{\text{Br}(B_d \rightarrow D \pi)} = 1.61 \pm 0.40(\text{stat}) \pm 0.40(\text{Br}) \pm 0.26(\text{sys}) \pm 0.20(\text{Fr})$

## Backup: Lepton+Track Cross Section

Run 162820 Event 7050764 Sun May 11 16:53:57 2003

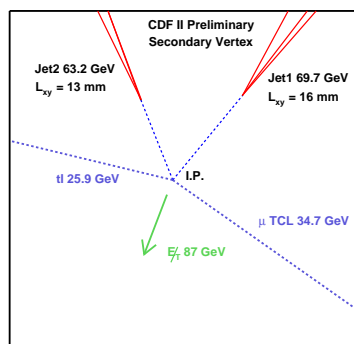

Tue Aug 5 13:29:39 2003

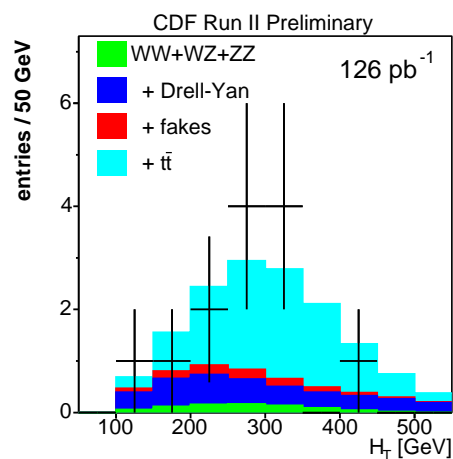

CDF II Preliminary  $\int L dt = 125.8 \text{ pb}^{-1}$

$t\bar{t}$  Cross section for various thresholds

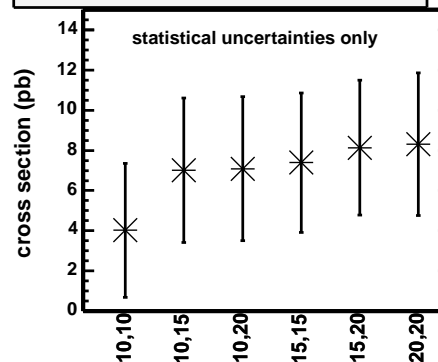

Signal/Noise for various thresholds

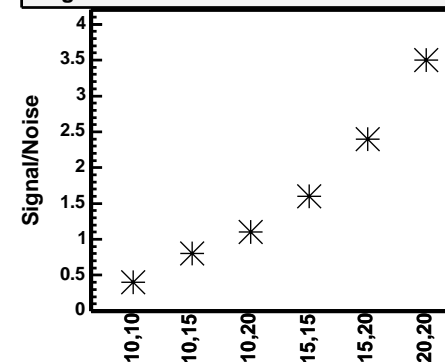

(Jet  $E_T$ , isolated track  $p_T$ ) threshold

- No anomalies in  $H_T$
- Cross section stable as function of  $E_T$ ,  $P_T$